

THORDON

THORDON BEARINGS INC.

Eliminating Stern Tube Oil Pollution The 12-Step Process

*Converting to a Thordon COMPAC
seawater lubricated bearing system
from an oil lubricated white metal
propeller shaft bearing system*

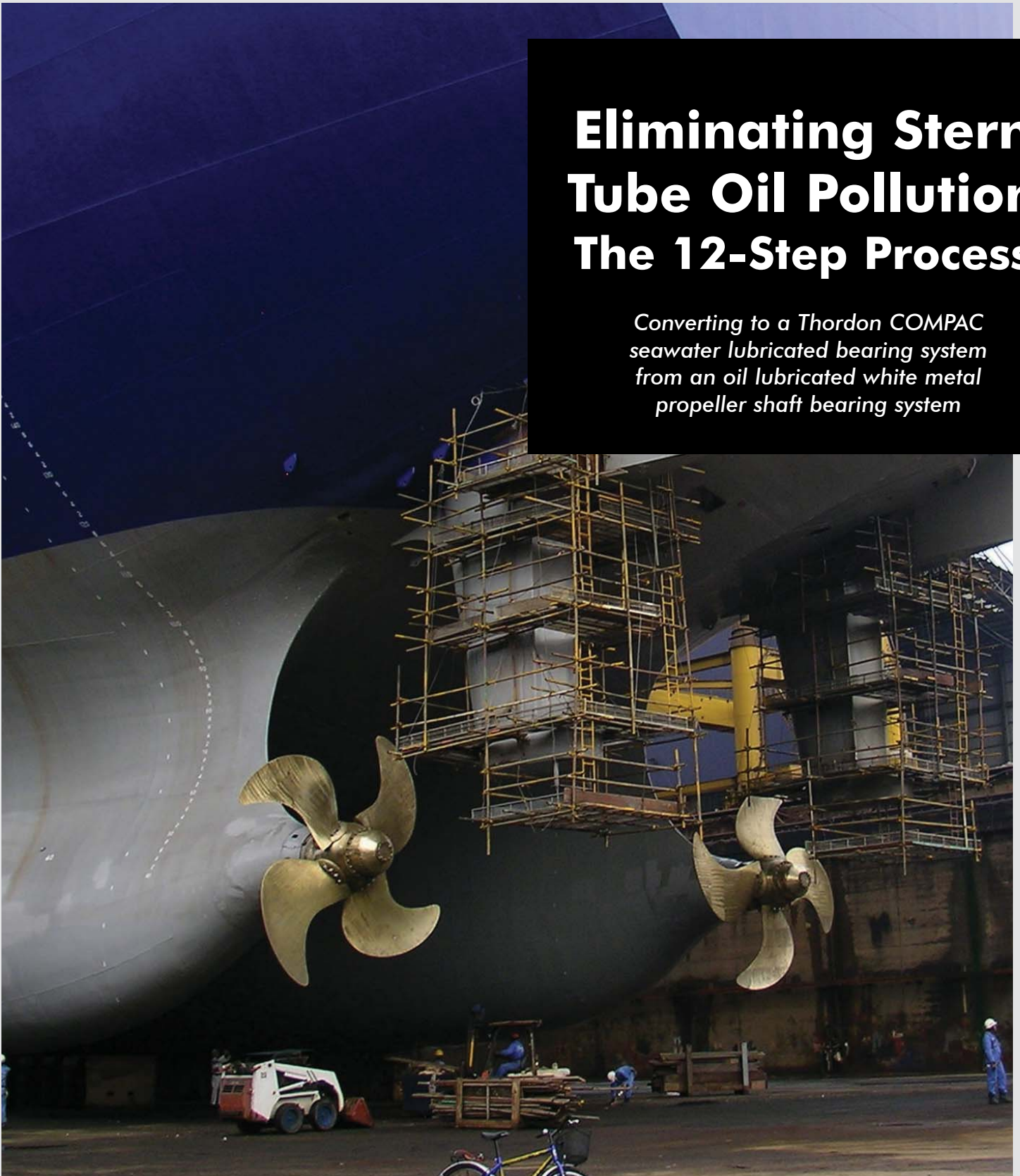

Why Convert to Seawater?

Environmental legislation is getting tougher. And even well maintained ships leak stern tube oil - a serious environmental issue facing commercial ship owners today. The simplest way to eliminate oil from the stern tube is to use Thordon non-metallic seawater lubricated COMPAC shaft bearings. COMPAC is a pollution-free, high performance, low maintenance bearing system used on cruise ships, bulk carriers, tankers, ferries, AHTS's, dry cargo and tugs - operating around the world with excellent results.

What is a COMPAC seawater lubricated stern tube bearing system?

Seawater is used as lubrication instead of oil and non-metallic Thordon COMPAC bearings are used in place of white metal bearings. The seawater is taken from the sea, pumped through the bearings and returns to the sea (see page 3 for illustration). Use of Thordon seawater lubricated bearings eliminates the aft seal, as well as the storage, sampling and disposal of oil. The potential impact of stern tube oil pollution is zero. One significant difference, however, is that the propeller shaft and stern tube requires corrosion protection from the seawater. Corrosion protection may mean a higher up-front cost for the stern tube bearing system as bronze liners are recommended. However, with the elimination of the aft seal and associated maintenance, the up-front costs are recouped in lower in-service costs along with no aft seal damage worries nor heavy pollution fines and bad publicity.

Thordon Bearings: The recognized leader in seawater lubricated bearing technology

Thordon gained its experience with seawater lubricated propeller shaft bearings with many of the world's Navies and Coast Guards that have almost always used seawater for their propeller shaft bearings for safety reasons and for its non-catastrophic failure mode. Today however, more and more commercial ship owners are seeing the proven performance with over 2000 commercial ships currently operating with Thordon seawater lubricated propeller shaft bearings.

Fitted to over 2000 ships, Thordon seawater lubricated propeller shaft bearing systems eliminate the risk of oil leakage from stern seals, provide excellent operational and bearing wear performance as well as offering lower in-service costs.



What would a COMPAC Conversion Package include?

- An assessment of original bearing loading condition
- Conversion design package and work schedule
- Thordon COMPAC seawater lubricated (orange) bearings
- Bronze shaft liners
- Thor-Coat shaft coating
- Water lubricated forward seal
- Thordon Water Quality Package

Tactics to minimize the cost of the conversion

- Conduct engineering up front to anticipate problems
- Utilize standard designs
- Firm quotes for work
- Tie conversion into tailshaft survey cycle
- Plan ahead with plenty of time in advance

Review of Existing Ship Parameters

Before considering a Thordon COMPAC conversion, Thordon Bearings will require specific information from the ship to determine if the ship can be converted. Thordon will review the following:

- 1) that space is available for fitting of shaft liners to Classification Society required thickness
- 2) that bearing loads are acceptable to Classification Society limits for water lubricated bearings
- 3) to determine bearing offsets and machining such as required etc. to maintain the existing shaft centerline alignment.

Once these topics are reviewed and deemed achievable, Thordon will advise if the conversion is possible. A typical COMPAC conversion will involve the following 12 step process.

COMPAC

SEAWATER LUBRICATED STERN TUBE BEARING SYSTEM



THOR-COAT SHAFT COATING

- Thordon's tough new modified epoxy coating, designed to provide 10 year integrity against corrosion



THORDON WATER QUALITY PACKAGE

- A Thordon Water Quality Package delivers a consistent supply of conditioned water to both the FWD seal and all bearings. A separate detailed brochure on the Thordon Water Quality Package is available

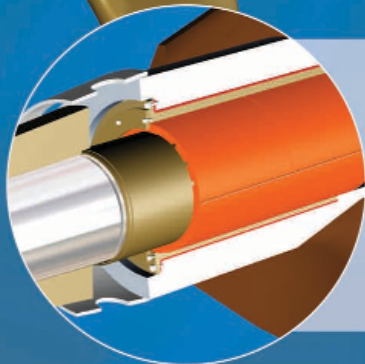
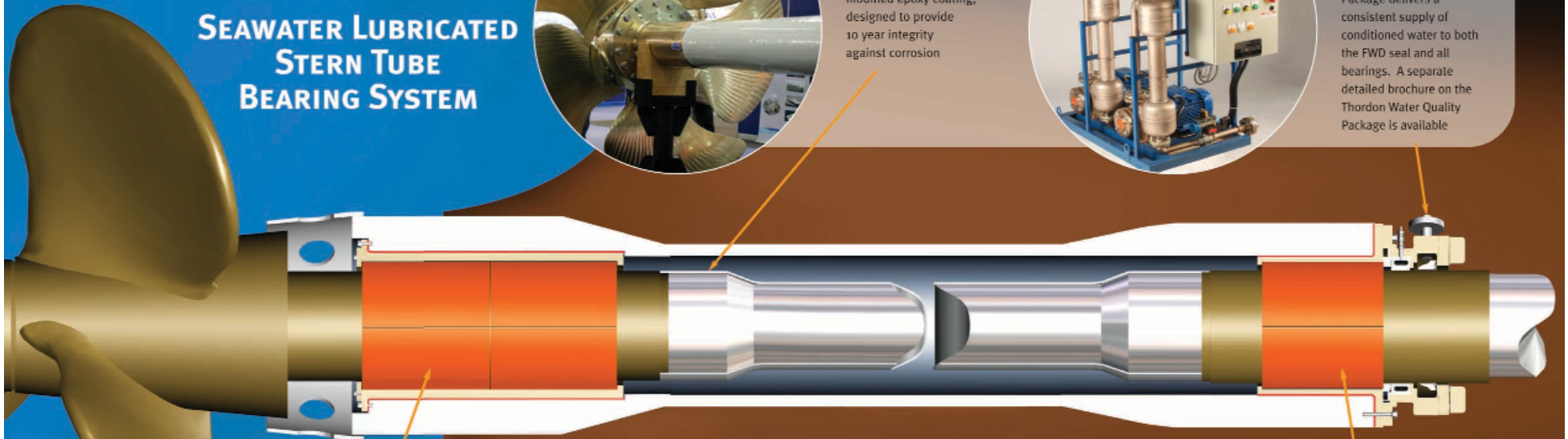

AFT COMPAC BEARING SYSTEM

- COMPAC bearing in bronze carrier with retaining ring
- Thordon recommended shaft liner in way of the bearings
- No AFT seal required

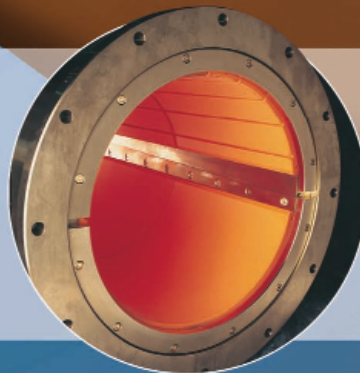

COMPAC SINGLE TAPERED KEY DESIGN

- COMPAC split bearing with a single tapered key allows bearings to be withdrawn, inspected and re-installed in a matter of hours with the shaft in place

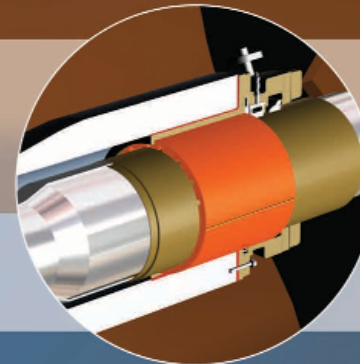

FWD COMPAC BEARING SYSTEM

- COMPAC bearing in bronze carrier
- Thordon recommended shaft liner in way of the bearings
- Face type FWD shaft seal shown here

The COMPAC Conversion Process

A Pictorial Overview of the 12 Step Process

STEP 1. Engineering and suitability review

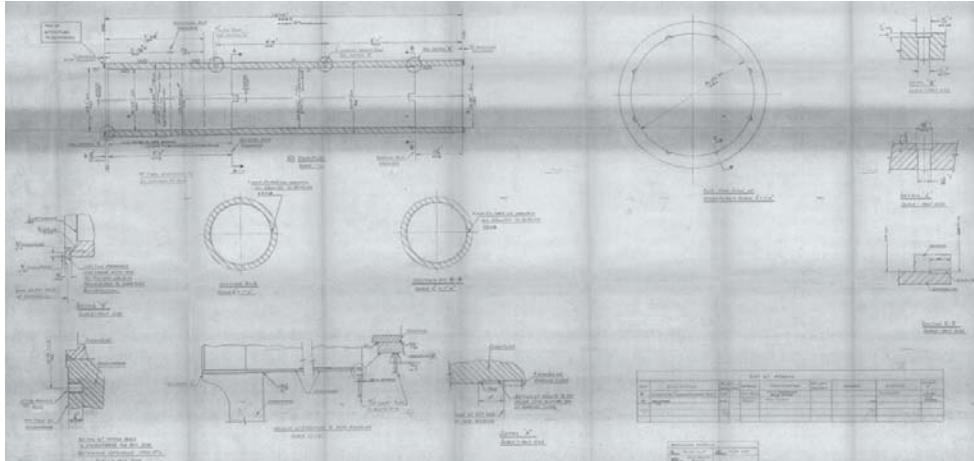

STEP 2. Drain Oil, remove shafts, clean and verify dimensions



Inspect FWD and Aft stern tube



Remove the original white metal bearings



STEP 3. Machine shaft liner ID



STEP 4. Heat liners (as required) for interference fit on shaft



Liners are heated and shrunk fit to the shaft



Shaft liner installation can be done horizontally or vertically

STEP 5. Machine OD of shaft liners to correct size and finish



Shaft liners are machined on lathe

STEP 6. Shaft preparation and application of Thor-Coat shaft coating



Shaft between liners is cleaned and prepared for shaft coating



Shaft is coated with Thor-Coat corrosion free coating and anti-fouling coating

STEP 7. If bearing carriers are required, correctly position carriers and install

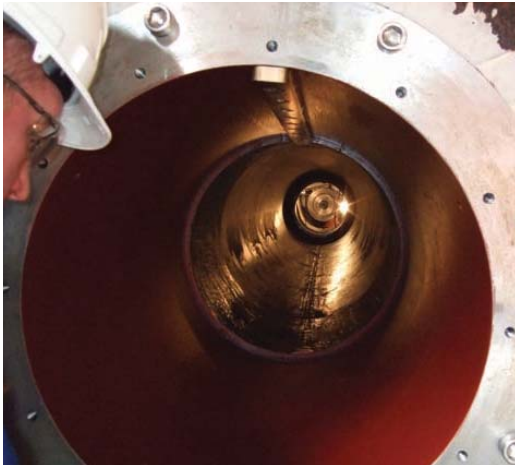

Stern tube housing is coated with anti-corrosion paint

STEP 8. Machining COMPAC bearings

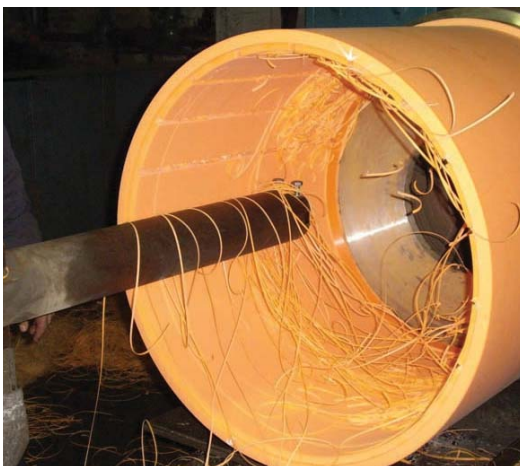

STEP 9. Interference fitting of COMPAC bearings via freezing



Bearing is cooled in liquid nitrogen and fitted into stern tube

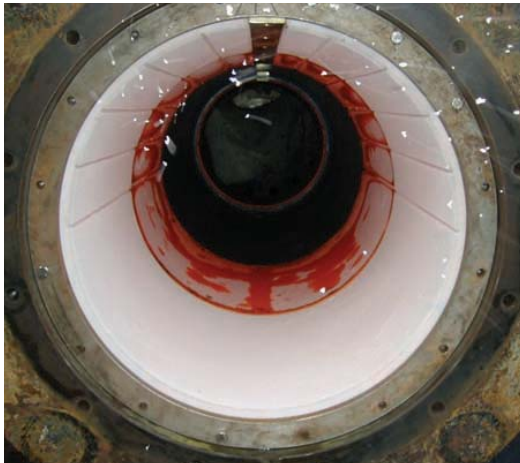

Single Key Design - bronze key fitted at 12:00

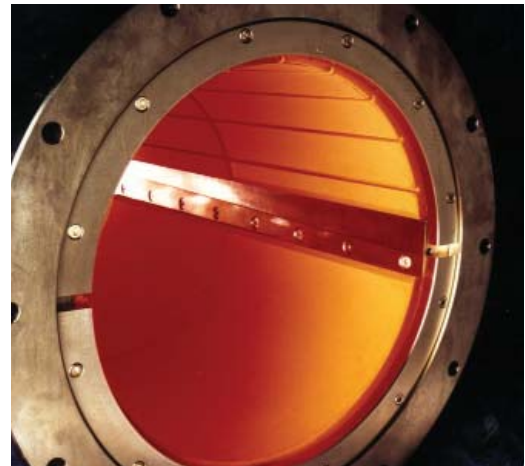

Split Tapered Key Design - allowing bearing removal with shaft in place

STEP 10. Refit propeller shaft



Shaft is fitted back into stern tube



When refitting shaft, care is taken to protect shaft coating from damage from chains, etc.

STEP 11. Fit seal and confirm seal integrity

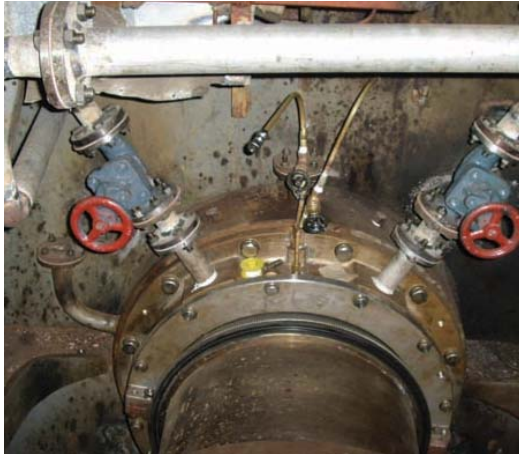

Inlet water pipes connected to forward seal

STEP 12. Supply clean water to bearings with a Thordon Water Quality Package



Thordon single pump, single separator
Water Quality Package



Thordon double pump, double separator
Water Quality Package

Conclusion

The seawater lubricated COMPAC stern tube bearing system operates with only one (FWD) shaft seal. Proven in the toughest marine environments, Thordon Bearings offer:

- reduced seal maintenance costs (no aft seal)
- elimination of stern tube oil
- no storage of oil
- no sampling of oil
- no disposal of oil
- no leaking of oil

Thordon seawater lubricated propeller shaft bearing systems eliminate oil leakage from stern seals resulting in zero pollution risk, provide excellent operational and bearing wear performance as well as offering lower in-service costs.



CSL Acadian converted to seawater lubricated COMPAC from oil in 2006

CUSTOMER FOCUSED TO QUICKLY MEET YOUR NEEDS

Quick and Responsive Service

It takes quality products to be globally successful in the marine bearing industry. It also takes great service to keep customers coming back.

Thordon Bearings Inc. is geared to respond quickly to new shipbuilding and conversion projects. Thordon bearings arrive quickly, fit right and last!

Extensive Distribution Network

Thordon Bearings has an extensive distribution network to supply our global customers. More than 70 distributors in 100 countries carry extensive inventories of Thordon's common bearing sizes which are backed by large regional and head office inventories. Non-standard requests are met with responsive design, quick machining and speedy delivery.

Application Engineering

Thordon engineers work closely with customers to provide innovative bearing system designs and solutions. We offer in-house design, CAD and the proprietary Thordon Bearing Sizing Calculation Program to help correctly size our bearings.

Our decades of experience mean that we offer the right technical support during design, machining, installation and operation.

Manufacturing Quality

Thordon Bearings Inc. is a family-owned company that operates a state-of-the-art polymer processing plant and new product development facilities in Burlington, Ontario, Canada.

We manufacture to ISO 9001:2008 Quality System requirements. Contact us for references for our installations.

High Performance Bearings and Shaftline Products; Industry-Leading Service

Thordon Bearings is an industry leader in the design, manufacture, supply and installation of high performance, marine bearings systems.



ZERO POLLUTION | HIGH PERFORMANCE | BEARING SYSTEMS

3225 Mainway Drive, Burlington, Ontario L7M 1A6 Canada
Tel: +1.905.335.1440 Fax: +1.905.335.4033
www.ThordonBearings.com